

Fineline Diffusers

SERIES LD linear bar grilles are designed for supply and return air distribution in heating, cooling and ventilating applications which call for diffusers having long or continuous slender appearance, fixed air discharge angles of zero or 15 degrees, and installed in walls, floors, sills or ceilings.

CONSTRUCTION is of extruded aluminium face, bars and frame of alloy 6063-T5, notched mullions, mechanically compressed together to form a powerfully bonded core, which is welded at mullion ends to the frame. 'F' models for floor use, have double mullions and 30 x 30 x 15 x 3 Solid 'Z' frames.

Model	Bar		
	Width mm	Spacing mm	Deflection
LD-600	3.25	6.35	0°
LD-615	3.25	6.35	15°
LD-1200	3.25	12.5	0°
LD-1215	3.25	12.5	15°
LDH-1200	5.6	12.5	0°
LDHF-1200+	5.6	12.5	0°
LDH-1215	5.6	12.5	15°
LDHF-1215+	5.6	12.5	15°
LDH-2500*	5.6	25	0°
LDH-2515*	5.6	25	15°

* Return/Exhaust Diffuser + Suitable for floor applications

WIDTH maximum for 'F' models is:

Continuous traffic: 200mm, Occasional traffic: 300mm. All models can be furnished with mitred 90° corners, or other angles where templates are furnished to the factory. Refer illustrations on this sheet for corner descriptions. The minimum length is 200mm. The maximum length for a single section is 2.8m.

Accessory Damper

Available with opposed blade dampers, screwdriver operated through the face. Specify OBD#1.

Notes

General Notes to be read in conjunction with performance tables on the following pages.

This data is reliable information for cooling, ventilating and heating applications.

1. All pressures are Pa (N/m²).

2. Minimum throw values refer to a terminal velocity of 0.75 m/s and maximum to 0.25 m/s, for a 1200mm active section with a cooling temperature differential of 12°C.

The multiplier factors listed in the table below are applicable for other lengths.

Active Length	Terminal Velocity	
	0.75 m/s	0.25 m/s
300mm	0.5	0.7
3000mm Or Continuous	1.6	1.2

Mitred Corners

Outside corner (Side wall)

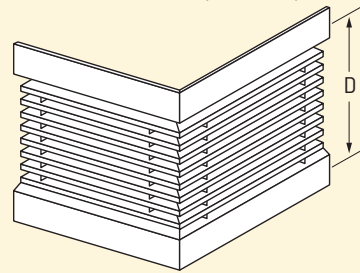

Inside corner (Side wall)

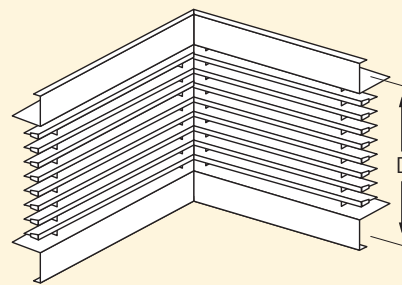

Floor, Ceiling or Sill

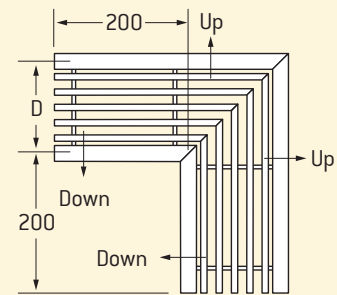

Note: When specifying corners ensure to nominate the blade orientation (up or down) if using the 15° blade.

3. The NC values are based on a room absorption of 10dB, re 10⁻¹² watts and a 3000mm active section.

Use the following multipliers for other active lengths.

NC CORRECTION FOR LENGTH											
Active Length, mm	300	600	1000	1200	1800	2400	3000	4500	6000	7500	9000
	-10	-7	-5	-4	-2	-1	0	+2	+3	+4	+5

4. Return Intake - When used as a return intake the NC value given will be increased by 4 and the negative static pressure will be 0.8 times the total pressure shown.

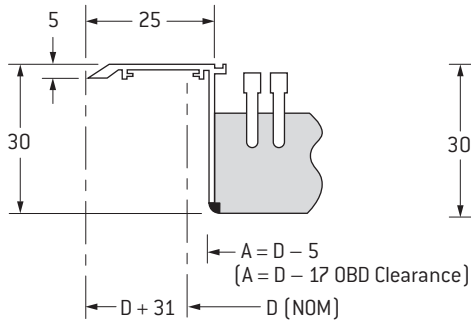

Style No.1 (Fixed Core)*
(Suitable for use with RC frame-- see page 216E)

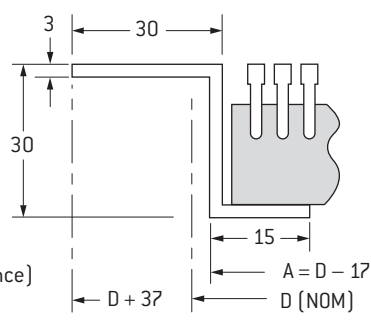

Style No.2 (Removable Core)
Square Edge

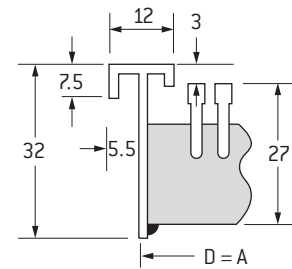

Style No.3 (Fixed Core)*
(For Cabinet or Duct Edge Mounting)

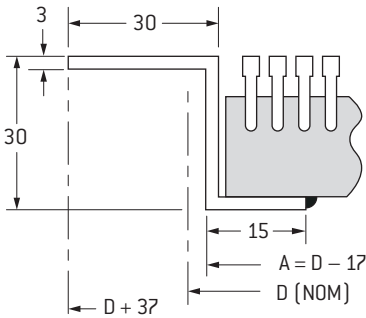

Style No.4 (Fixed Core)
Square Edge

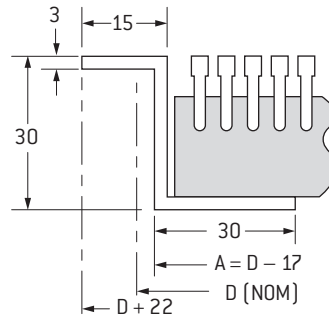

Style No.4A (Fixed or Removable Core)
Square Edge

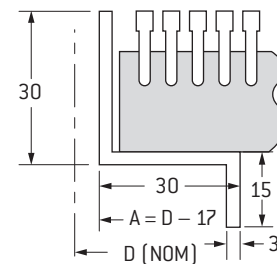

Style No.4B (Fixed or Removable Core)
(Flangeless Frame)
Square Edge

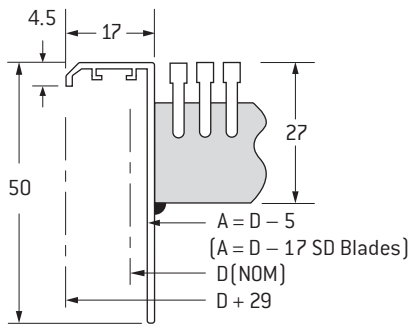

Style No.5 (Fixed Core)*
(Rear SD Blades not Shown)

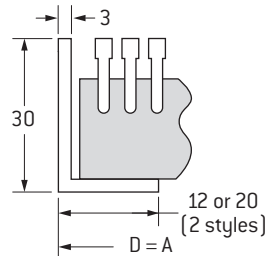

Style No.6 (Fixed or Removable Core)
(Flangeless Frame)

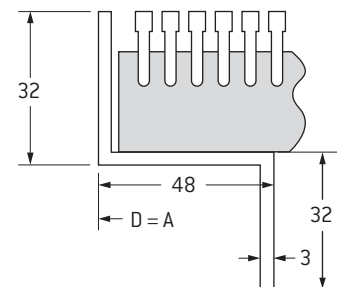

Style LDH-CF (Fixed or Removable Core)
(Flangeless Frame)
(Computer Floor)

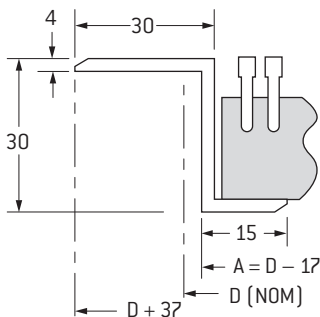

Style No.7 (Fixed or Removable Core)
(Bevelled Edge Flange)

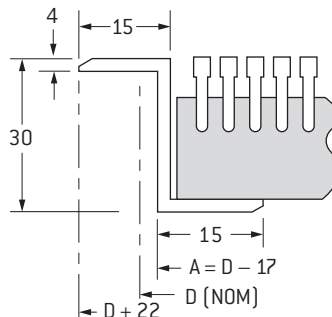

Style No.7A (Fixed or Removable Core)
(Bevelled Edge Flange)

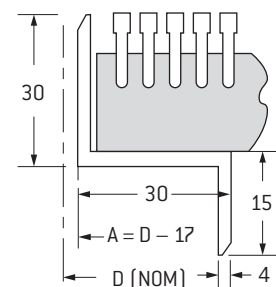

Style No.7B (Fixed or Removable Core)
(Bevelled Edge Flange)

See page 62B for PMF Style Frame, for Plaster Mounting of Flangeless Grilles.

* Ceiling / Wall application

Dimensional Notes

1. Where single piece units are required, maximum length is 2.8 metres. Unless otherwise specified these are furnished with mitred corners.
2. Where continuous lengths greater than 2.8 metres are required, modules will be selected as two end sections (one mitred corner end per section) and the required number of equal length intermediate sections with alignment strips.

3. Actual length 'A' is 'D'-17, unless shown to the contrary.

4. Other styles may be available, contact your local Holyoke branch.

Model: LDH-2500 Return/Exhaust Grille

0° deflection
25mm spacing
5.1mm louver

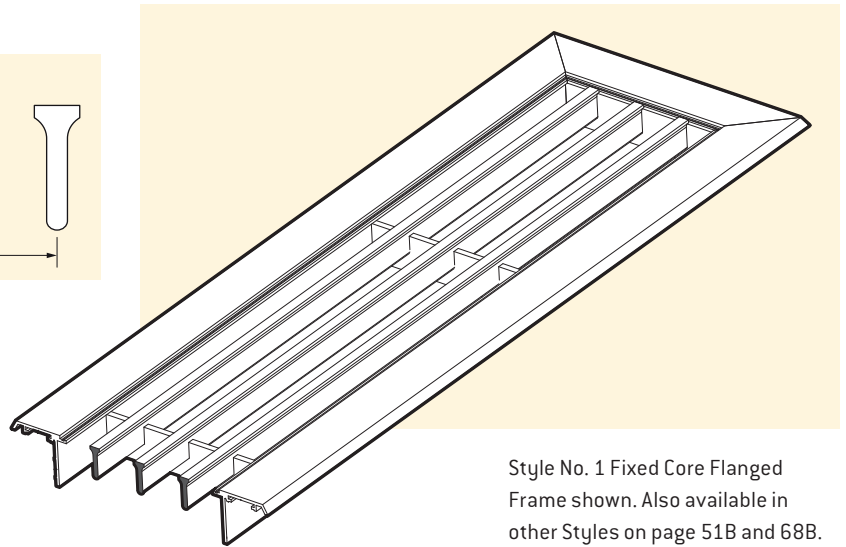
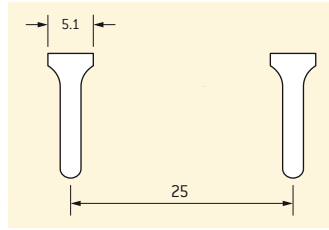

Style No. 1 Fixed Core Flanged Frame shown. Also available in other Styles on page 51B and 68B.

Dimensions

D	A	Number of Bars
Listed Size	Opening	
150	120	4
200	170	6
250	220	8
300	270	10
400	370	14
500	470	18
600	570	22
700	670	26
800	770	30

The LDH-2500 Linear Return/Exhaust Diffuser has heavy bar type louvers spaced at 25mm centres. It is available in any desired length and can also be supplied with alternative frame types including the PMF system and RC Frame. When used with the PMF system see notes on page 68B. Model LDH-2515 is also available - same construction as the LDH-2500 but with angled 15° fixed blades.

Heavy Duty Application

Where heavy duty application is required, specify LDHF-2500 to signify heavier construction. These grilles have double mullions and frame style 4 solid surround. **Not suitable for floor applications.**

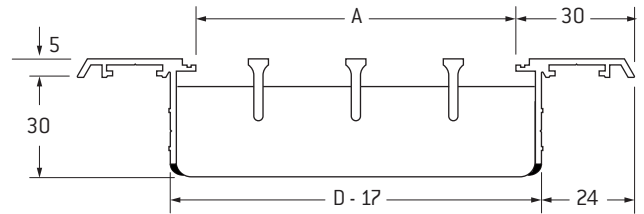

Core Area m ²	Nominal Size (mm)	Core Velocity (m/s)	NC 20						NC 30			
			2.18	2.73	3.27	3.92	4.41	5.01	5.61	6.10	6.76	8.01
		Vel Pressure (Pa)	3	4	6	9	12	15	19	22	27	39
		Neg SP (Pa)	8	12	16	23	29	37	45	54	65	88
0.013	150 x 150	m ³ /s	0.040	0.050	0.060	0.072	0.081	0.092	0.103	0.112	0.124	0.147
		NC	-	-	-	-	15	18	22	24	26	31
0.025	200 x 200	m ³ /s	0.071	0.094	0.113	0.141	0.157	0.179	0.204	0.212	0.234	0.278
		NC	-	-	-	15	18	22	24	26	31	33
0.041	250 x 250	m ³ /s	0.112	0.153	0.165	0.211	0.232	0.265	0.305	0.313	0.343	0.410
		NC	-	-	-	18	22	24	26	31	33	36
0.060	300 x 300	m ³ /s	0.133	0.182	0.218	0.280	0.308	0.352	0.406	0.413	0.453	0.541
		NC	-	-	-	20	21	25	31	32	34	39
0.111	400 x 400	m ³ /s	0.311	0.412	0.495	0.618	0.688	0.784	0.894	0.929	1.020	1.220
		NC	-	-	18	21	25	31	32	34	36	40
0.177	500 x 500	m ³ /s	0.481	0.657	0.709	0.907	0.997	1.140	1.310	1.340	1.470	1.760
		NC	-	15	20	24	30	32	33	35	38	42
0.259	600 x 600	m ³ /s	0.565	0.774	0.927	1.190	1.309	1.496	1.726	1.755	1.925	2.299
		NC	-	18	22	26	31	33	35	37	39	44
0.355	700 x 700	m ³ /s	0.888	1.187	1.426	1.795	1.991	2.272	2.599	2.683	2.956	3.517
		NC	-	18	22	26	31	33	35	37	39	44
0.467	800 x 800	m ³ /s	1.244	1.647	1.980	2.470	2.751	3.136	3.574	3.714	4.100	4.871
		NC	-	19	23	27	32	34	35	38	40	45
0.596	900 x 900	m ³ /s	1.584	2.138	2.408	3.048	3.369	3.845	4.408	4.547	4.998	5.959
		NC	-	21	24	30	32	33	35	38	42	46
0.736	1000 x 1000	m ³ /s	1.925	2.630	2.836	3.627	3.988	4.555	5.242	5.380	5.895	7.047
		NC	20	23	27	32	34	35	38	43	45	48

Guide Product Weights	
Model	Approximate Weight in Kg per metre x 150mm
LDH-2500	2.3

LD, LDH, LDHF, LDSD & PMF

Diffuser Description Code Examples and Suggested Specifications

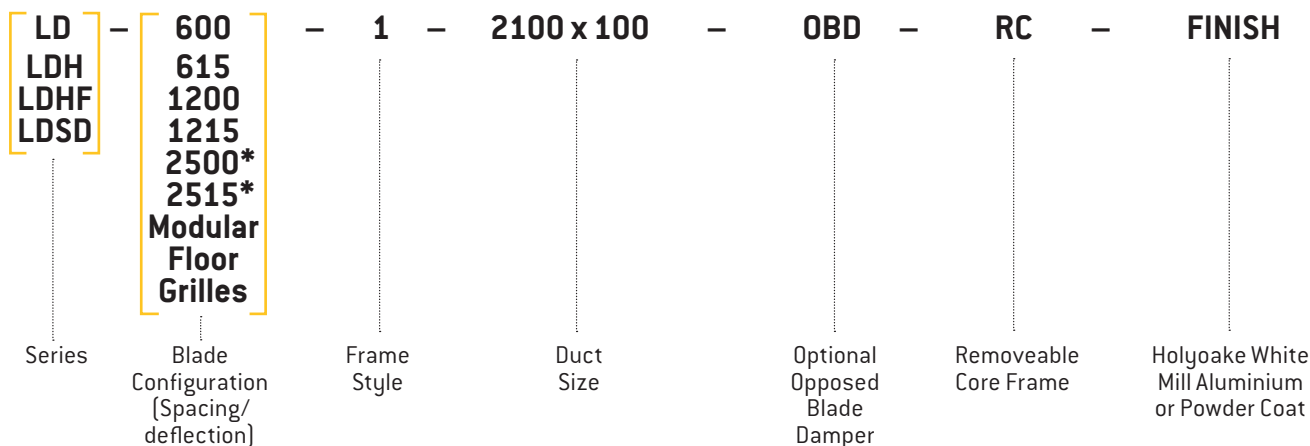

* Return/Exhaust Grilles, not suitable for floor applications.

The Holyoake LD Range of linear diffusers shall be of extruded aluminium construction. Blades shall be mechanically expanded into notched mullions spaced at nominal centres. Diffusers shall be fitted with accessory dampers and have optional frame styles and finish where indicated.

All shall be as manufactured by Holyoake.



Holyoake LDH-CF Computer Floor supply grilles shall be of extruded aluminium, welded construction, with blades mechanically expanded into double, notched mullions spaced at nominal centres. They shall be designed to withstand a concentrated load of 500 kg over an area of 645mm² (1 square inch) at the centre, with no permanent distortion and maximum deflection under load of 0.66mm. Accessory volume control dampers, adjustable through the face, shall be furnished where indicated.

The whole assembly shall be as manufactured by Holyoake.

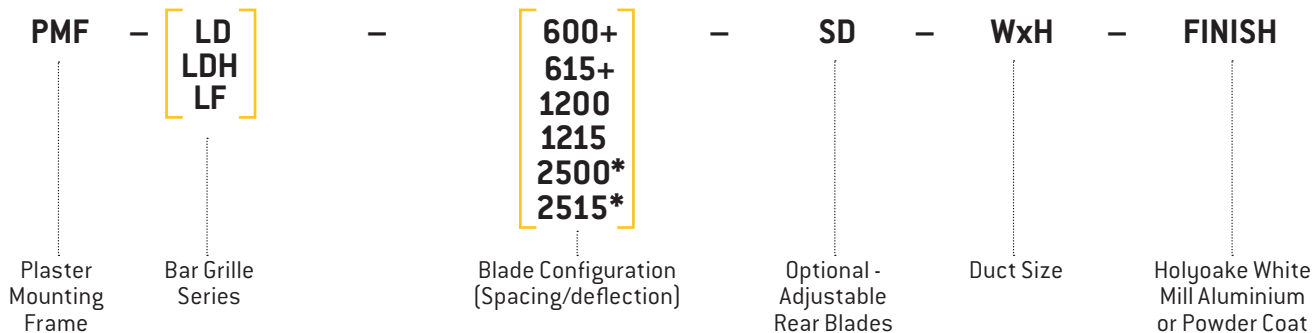

* Return/Exhaust Grilles, not suitable for floor applications. +See Notes on Page 68B.

Holyoake Series PMF – Plaster Mounting Frame shall be of extruded aluminium construction.

PMF Grilles shall have a flange width no greater than 6mm.

The Plaster Mounting Frame shall be fixed into a wall opening and plaster stopped before fitting of the Flangeless Grille. The Grille shall have blades notched into mullions spaced at nominal centres and may have a second row of adjustable 'SD' blades if specified.

All shall be as manufactured by Holyoake.

Note When LD Variants are ceiling mounted, seismic restraints are required, but not supplied.