

## Fineline Diffusers

SERIES LD linear bar grilles are designed for supply and return air distribution in heating, cooling and ventilating applications which call for diffusers having long or continuous slender appearance, fixed air discharge angles of zero or 15 degrees, and installed in walls, floors, sills or ceilings.

CONSTRUCTION is of extruded aluminium face, bars and frame of alloy 6063-T5, notched mullions, mechanically compressed together to form a powerfully bonded core, which is welded at mullion ends to the frame. 'F' models for floor use, have double mullions and 30 x 30 x 15 x 3 Solid 'Z' frames.

Model	Bar		
	Width mm	Spacing mm	Deflection
LD-600	3.25	6.35	0°
LD-615	3.25	6.35	15°
LD-1200	3.25	12.5	0°
LD-1215	3.25	12.5	15°
LDH-1200	5.6	12.5	0°
LDHF-1200+	5.6	12.5	0°
LDH-1215	5.6	12.5	15°
LDHF-1215+	5.6	12.5	15°
LDH-2500*	5.6	25	0°
LDH-2515*	5.6	25	15°

\* Return/Exhaust Diffuser + Suitable for floor applications

WIDTH maximum for 'F' models is:

Continuous traffic: 200mm, Occasional traffic: 300mm. All models can be furnished with mitred 90° corners, or other angles where templates are furnished to the factory. Refer illustrations on this sheet for corner descriptions. The minimum length is 200mm. The maximum length for a single section is 2.8m.

### Accessory Damper

Available with opposed blade dampers, screwdriver operated through the face. Specify OBD#1.

### Notes

General Notes to be read in conjunction with performance tables on the following pages.

This data is reliable information for cooling, ventilating and heating applications.

1. All pressures are Pa (N/m<sup>2</sup>).

2. Minimum throw values refer to a terminal velocity of 0.75 m/s and maximum to 0.25 m/s, for a 1200mm active section with a cooling temperature differential of 12°C.

The multiplier factors listed in the table below are applicable for other lengths.

Active Length	Terminal Velocity	
	0.75 m/s	0.25 m/s
300mm	0.5	0.7
3000mm Or Continuous	1.6	1.2

### Mitred Corners

#### Outside corner (Side wall)

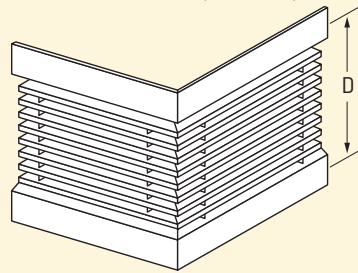

#### Inside corner (Side wall)

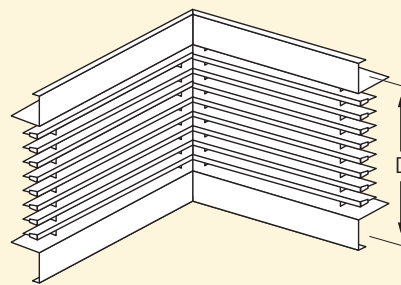

#### Floor, Ceiling or Sill

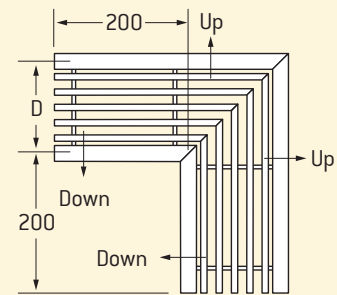

Note: When specifying corners ensure to nominate the blade orientation (up or down) if using the 15° blade.

3. The NC values are based on a room absorption of 10dB, re 10<sup>-12</sup> watts and a 3000mm active section.

Use the following multipliers for other active lengths.

NC CORRECTION FOR LENGTH											
Active Length, mm	300	600	1000	1200	1800	2400	3000	4500	6000	7500	9000
	-10	-7	-5	-4	-2	-1	0	+2	+3	+4	+5

4. Return Intake - When used as a return intake the NC value given will be increased by 4 and the negative static pressure will be 0.8 times the total pressure shown.

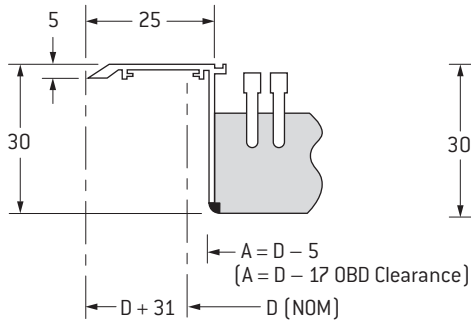

**Style No.1 (Fixed Core)\***  
(Suitable for use with RC frame-- see page 216E)

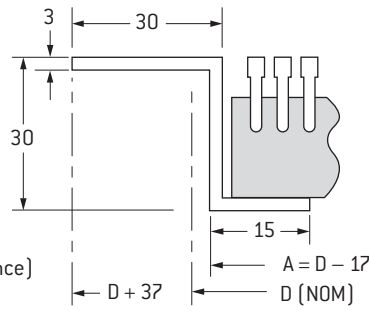

**Style No.2 (Removable Core)**  
Square Edge

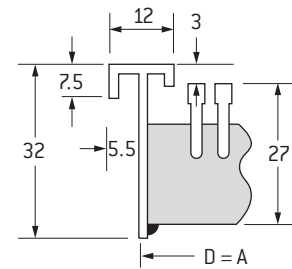

**Style No.3 (Fixed Core)\***  
(For Cabinet or Duct Edge Mounting)

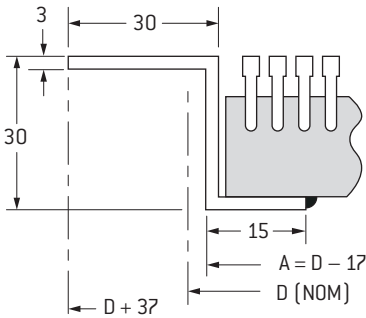

**Style No.4 (Fixed Core)**  
Square Edge

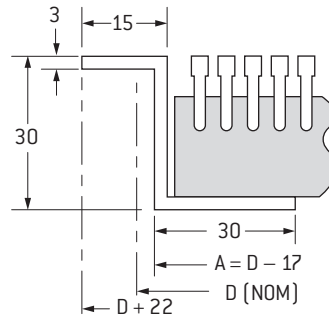

**Style No.4A (Fixed or Removable Core)**  
Square Edge

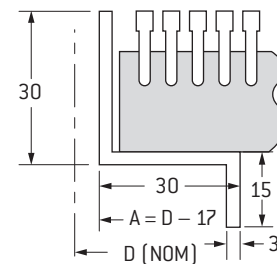

**Style No.4B (Fixed or Removable Core)**  
(Flangeless Frame)  
Square Edge

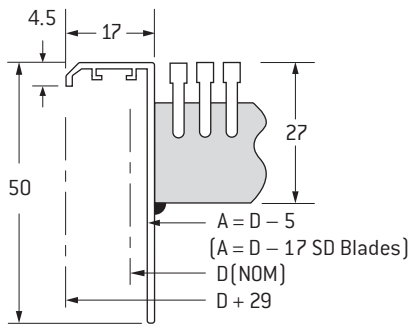

**Style No.5 (Fixed Core)\***  
(Rear SD Blades not Shown)

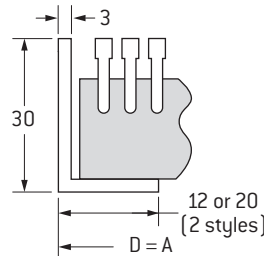

**Style No.6 (Fixed or Removable Core)**  
(Flangeless Frame)

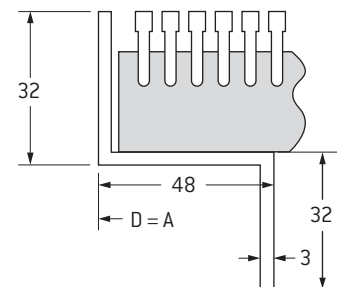

**Style LDH-CF (Fixed or Removable Core)**  
(Flangeless Frame)  
(Computer Floor)

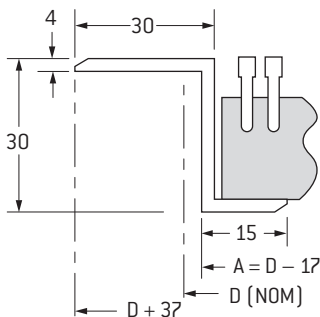

**Style No.7 (Fixed or Removable Core)**  
(Bevelled Edge Flange)

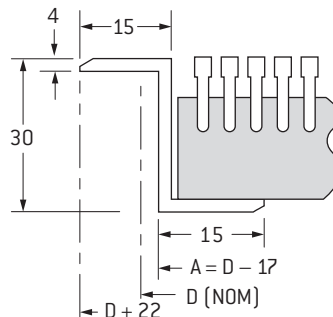

**Style No.7A (Fixed or Removable Core)**  
(Bevelled Edge Flange)

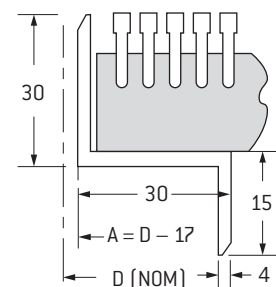

**Style No.7B (Fixed or Removable Core)**  
(Bevelled Edge Flange)

See page 62B for PMF Style Frame, for Plaster Mounting of Flangeless Grilles.

\* Ceiling / Wall application

## Dimensional Notes

1. Where single piece units are required, maximum length is 2.8 metres. Unless otherwise specified these are furnished with mitred corners.  
2. Where continuous lengths greater than 2.8 metres are required, modules will be selected as two end sections (one mitred corner end per section) and the required number of equal length intermediate sections with alignment strips.

3. Actual length 'A' is 'D'-17, unless shown to the contrary.

4. Other styles may be available, contact your local Holyoke branch.

# LDH – Selection Data

Model: **LDH-1215/LDHF-1215**

- 15° deflection
- 12.5mm spacing
- 5.1mm louver

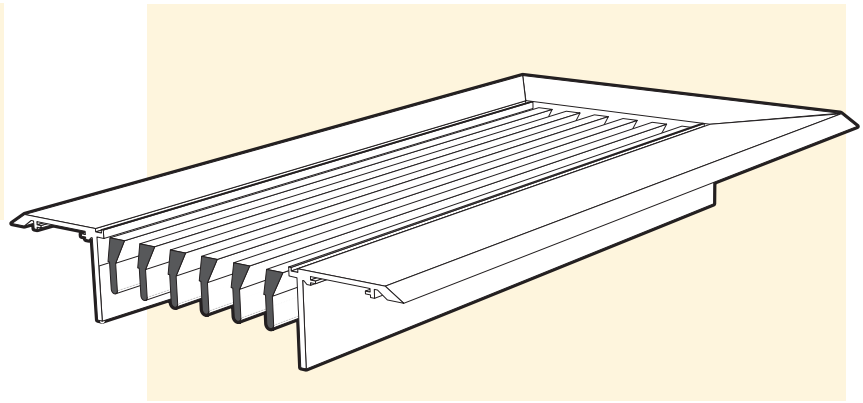
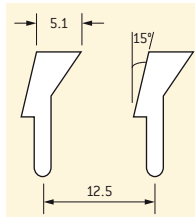

## Dimensions

D	A	Number of Bars
Listed Size	Opening	
50.0	21.0	2
62.5	33.5	3
75.0	46.0	4
87.5	58.5	5
100.0	71.0	6
125.0	96.0	8
150.0	121.0	10

Same basic design as Model LDH-1200 except that louvers are fixed at 15° deflection. Louvers are spaced on 12.5 centres. Furnished in all standard widths as shown below.

## Floor Application

Where required for floor use, specify LDHF-1215 to signify heavier construction.

LDHF-1215 grilles have double mullions and frame style 4 solid surround.

Continuous traffic maximum width 200mm.

Occasional traffic maximum width 300mm.

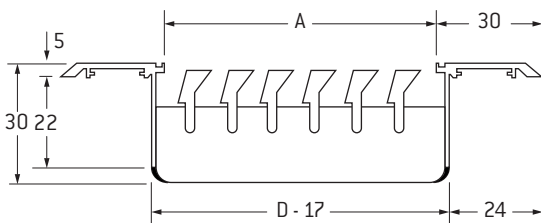

Size & Area m <sup>2</sup> /m	Total Pressure	3	7	12	19	27	37	48	61	75
50mm	Flow m <sup>3</sup> /s/m	0.029	0.045	0.059	0.074	0.090	0.104	0.119	0.133	0.149
	NC	-	-	19	26	31	36	40	43	46
0.015	Throw, Sill or Floor	0.3-0.3	1.2-1.2	2.1-2.1	2.7-3.0	3.4-4.0	3.7-4.6	4.3-5.5	4.9-6.1	5.2-6.7
	m Side Wall	0.9-2.1	1.5-3.7	2.1-4.9	2.7-6.1	3.4-7.0	3.7-7.6	4.3-8.5	4.9-9.5	5.2-10.0
62.5mm	Flow m <sup>3</sup> /s/m	0.042	0.062	0.084	0.104	0.124	0.146	0.166	0.186	0.208
	NC	-	-	19	26	31	36	40	43	46
0.020	Throw, Sill or Floor	0.3-0.3	1.5-1.5	2.7-2.7	3.4-3.7	4.0-4.6	4.6-5.5	5.2-6.4	6.1-6.7	6.7-7.0
	m Side Wall	1.2-2.4	1.8-4.0	2.7-5.2	3.4-6.4	4.0-7.3	4.6-8.2	5.2-9.5	6.1-10.4	6.7-11.6
75mm	Flow m <sup>3</sup> /s/m	0.053	0.085	0.107	0.133	0.160	0.186	0.214	0.240	0.267
	NC	-	-	19	26	31	36	40	43	46
0.026	Throw, Sill or Floor	0.6-0.6	1.8-1.8	3.0-3.4	3.7-4.3	4.6-5.5	5.5-6.1	6.1-7.0	7.0-7.6	7.6-7.6
	m Side Wall	1.2-2.7	2.1-4.3	3.0-5.5	3.7-6.7	4.6-7.9	5.5-9.2	6.1-10.1	7.0-11.3	7.6-12.2
87.5mm	Flow m <sup>3</sup> /s/m	0.065	0.098	0.130	0.163	0.195	0.228	0.260	0.293	0.326
	NC	-	-	20	27	32	37	41	44	47
0.032	Throw, Sill or Floor	0.6-0.6	2.4-2.4	3.4-3.7	4.6-4.6	5.2-5.8	6.4-6.7	6.7-7.6	7.6-7.9	8.5-8.8
	m Side Wall	1.5-3.0	2.4-4.6	3.4-6.1	4.6-7.3	5.2-8.5	6.4-10.0	6.7-10.7	7.6-11.9	8.5-13.1
100mm	Flow m <sup>3</sup> /s/m	0.079	0.118	0.158	0.197	0.236	0.276	0.315	0.353	0.394
	NC	-	-	21	28	33	38	42	45	48
0.038	Throw, Sill or Floor	0.9-0.9	2.7-2.7	4.0-4.0	4.9-5.2	5.8-6.4	6.7-7.0	7.3-7.9	8.2-8.2	9.2-9.2
	m Side Wall	1.8-3.4	3.0-5.2	4.0-6.4	4.9-7.6	5.8-8.8	6.7-10.1	7.3-11.3	8.2-12.5	9.2-13.4
125mm	Flow m <sup>3</sup> /s/m	0.104	0.155	0.208	0.259	0.310	0.363	0.414	0.467	0.518
	NC	-	-	21	28	33	38	42	45	48
0.050	Throw, Sill or Floor	1.2-1.2	3.0-3.0	4.3-4.3	5.5-5.5	6.4-6.7	7.3-7.6	7.9-8.5	9.2-9.2	9.8-9.8
	m Side Wall	2.4-4.0	3.4-5.5	4.3-7.0	5.5-8.2	6.4-9.5	7.3-10.7	7.9-11.9	9.2-13.1	9.8-14.0
150mm	Flow m <sup>3</sup> /s/m	0.130	0.195	0.260	0.326	0.391	0.456	0.521	0.586	0.651
	NC	-	-	23	30	35	40	44	47	50
0.064	Throw, Sill or Floor	1.5-1.5	3.0-3.0	4.6-4.6	5.8-5.8	7.0-7.0	7.6-7.6	8.5-8.8	9.5-9.5	10.7-10.7
	m Side Wall	2.7-4.6	4.0-6.1	5.2-7.6	6.1-8.8	7.0-10.0	7.9-11.3	8.5-12.2	9.2-13.4	10.7-14.3

## Guide Product Weights

Model	Approximate Weight in Kg per metre x 150mm
LDH-1215	2.3
LDHF-1215	3.0

## Note

Refer to page 51B, Frame Style 4, for LDHF Surround.

# LD, LDH, LDHF, LDSD & PMF

## Diffuser Description Code Examples and Suggested Specifications

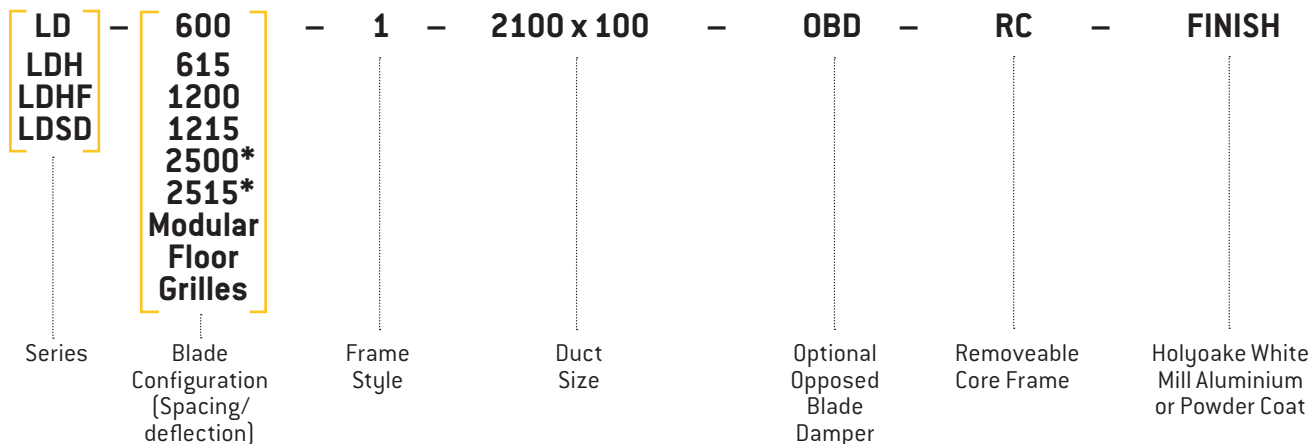

\* Return/Exhaust Grilles, not suitable for floor applications.

The Holyoake LD Range of linear diffusers shall be of extruded aluminium construction. Blades shall be mechanically expanded into notched mullions spaced at nominal centres. Diffusers shall be fitted with accessory dampers and have optional frame styles and finish where indicated.

All shall be as manufactured by Holyoake.



Holyoake LDH-CF Computer Floor supply grilles shall be of extruded aluminium, welded construction, with blades mechanically expanded into double, notched mullions spaced at nominal centres. They shall be designed to withstand a concentrated load of 500 kg over an area of 645mm<sup>2</sup> (1 square inch) at the centre, with no permanent distortion and maximum deflection under load of 0.66mm. Accessory volume control dampers, adjustable through the face, shall be furnished where indicated.

The whole assembly shall be as manufactured by Holyoake.

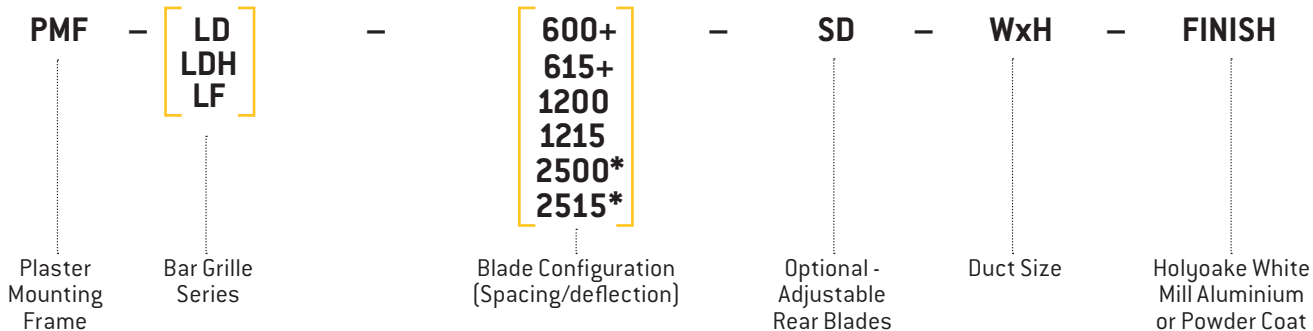

\* Return/Exhaust Grilles, not suitable for floor applications. +See Notes on Page 68B.

Holyoake Series PMF – Plaster Mounting Frame shall be of extruded aluminium construction.

PMF Grilles shall have a flange width no greater than 6mm.

The Plaster Mounting Frame shall be fixed into a wall opening and plaster stopped before fitting of the Flangeless Grille. The Grille shall have blades notched into mullions spaced at nominal centres and may have a second row of adjustable 'SD' blades if specified.

All shall be as manufactured by Holyoake.

**Note** When LD Variants are ceiling mounted, seismic restraints are required, but not supplied.