

# SD, DD & MDD – All Grilles & Registers

## Horizontal Deflection (SPREAD)

The accompanying diagrams are based on actual tests. They show the relationship of spread to throw for a typical high sidewall supply outlet selection.

Notice that the outer Light Green shaded area represents the 0.25 m/s envelope, the White area the 0.5 m/s envelope and the Dark Green area the 0.75 m/s envelope.

The angle of spread also affects the angle of drop of the air stream. For a given temperature, volume and core velocity, the wider the deflection the smaller the drop.

Holyoake grilles and registers can be selected with a single set of louvers (single deflection) for adjusting horizontal, or vertical deflection, or with two sets of louvers (double deflection) for adjusting both horizontal and vertical deflections.

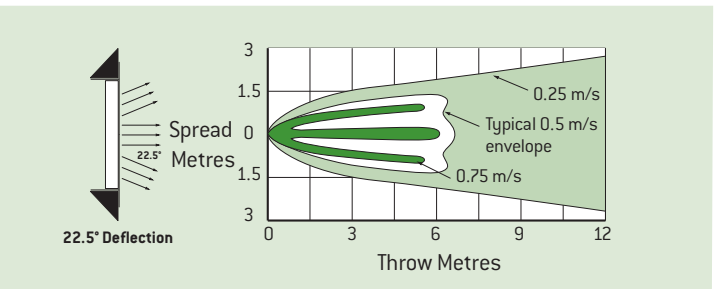
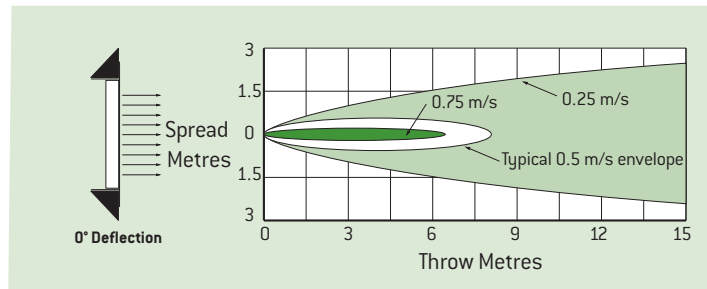
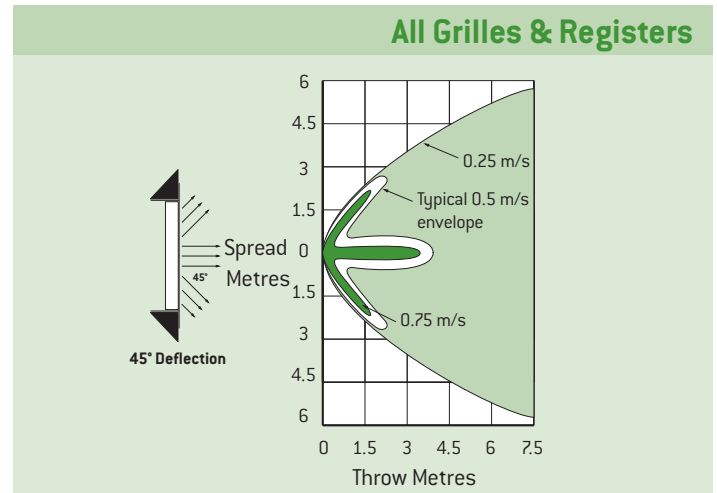

## General Notes On Performance

Grilles & Registers shown in this section.

- Pressure: All pressures are in Pascals.
- Throw: Maximum throws are to a terminal velocity of 0.25 m/s, middle to 0.5 m/s and minimum to 0.75 m/s.
- Sound: The NC values are based on a room absorption of 10 dB, re  $10^{-12}$  watts, with a single register operating at a 0 degree deflection setting. For deflection settings of 22.5 and 45 degrees, increase the stated sound levels by 1 and 7 NC respectively.
- Deflection: The stated deflection settings refer to horizontal deflection as shown in the spread diagrams. For a 20 degree upward deflection, use the throw rating for a 0 degree setting and the total pressure for a 22.5 degree horizontal setting.

**NOTE: The capacity tables shown on Pages 206E - 209E are based on registers with Model DD – 20 cores and opposed blade dampers. The performance of other cores, with or without dampers, can be obtained from the correction table below.**

CORRECTIONS FOR VARIOUS CORE STYLES						
CORE STYLE	DAMPER	Ak/Ac	THROW	TOT. PRESS	NC	VEL.
SD - 20 & DD - 20	With Damper	0.78	1.00	1.00	0	1.00
	No Damper	0.83	0.97	0.88	-4	0.94
SD - 32 & DD - 32	With Damper	0.87	0.95	0.81	0	0.90
	No Damper	0.92	0.92	0.72	-5	0.85

Ak = Net Jet Area      NC = Corrections are Adders  
Ac = Core or Neck Area  
Throw and Total Pressure = Corrections are Multipliers

## Variable Volume Applications

ALL Holyoake supply grilles and registers, when properly selected, can be used on variable air volume applications with excellent results. Selection methods and application data are discussed in the Engineering Section of this catalogue.

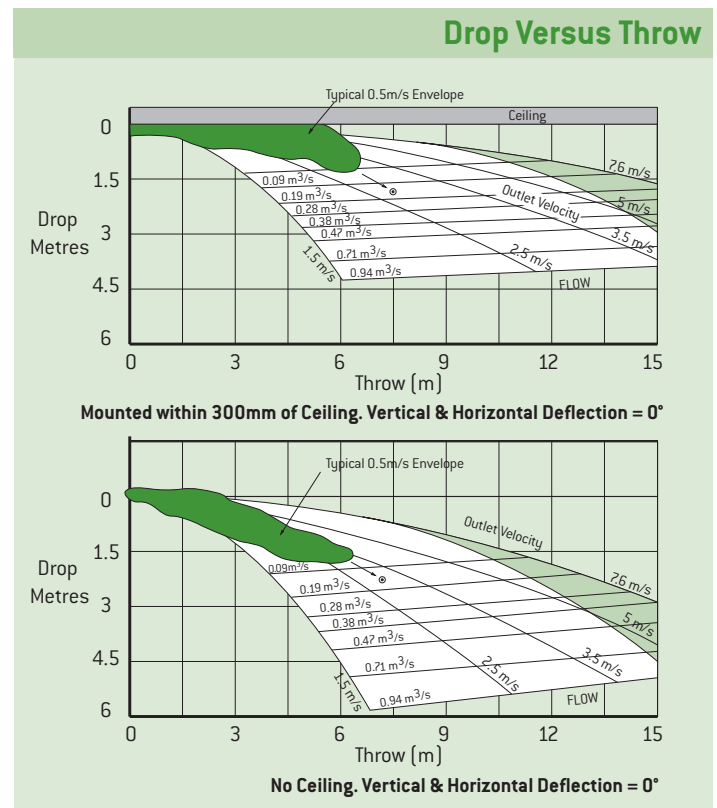

## Notes

1. Light green shading to the right of each of the two 'Drop Versus Throw' charts above indicates N.C. levels above 30.
2. Small circle in white area of each chart shows comparative performances of one size grille at 0.140 m<sup>3</sup>/s and 3.0 m/s outlet velocity.
3. Drop and throw values are based upon:
  - (a)  $V_t = 0.25$  m/s.
  - (b) Cooling  $\Delta t = 12^\circ$  K.
  - (c) Core style DDL & SDL - 20. See corrections this page for other styles.

# DD-20 & 32 – Supply Grilles & Registers

## Grille - Two Sets of Louver Blades

### Model: DDL-20

Two sets of louver blades. Front set parallel to long dimension. Rear set parallel to short dimension. All louver blades individually adjustable for any degree of deflection.

### Model: DDS-20

Same as DDL-20 except front louver blades parallel to short dimension, rear parallel to long dimension.

## Register - Two Sets of Louver Blades

### Model: DDL-20/OBD

Two sets of louver blades. Front set parallel to long dimension. Rear set parallel to short dimension. All louver blades individually adjustable for any degree of deflection. Opposed blade damper, screwdriver operated from face.

### Model: DDS-20/OBD

Same as DDL-20/OBD except front louver blades parallel to short dimension, rear parallel to long dimension.

## All Aluminium. 20mm Airfoil Louvers

Face View, DDL20

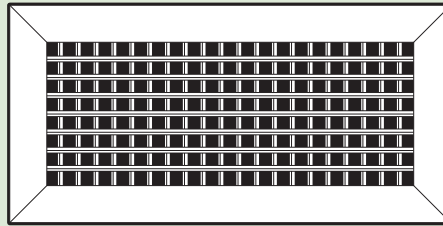

End View, DDL20

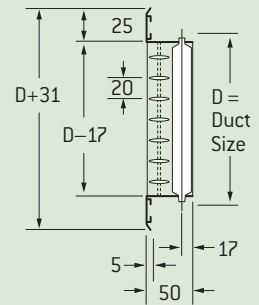

Face View, DDL20/OBD

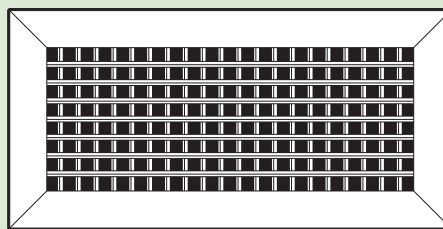

End View, DDL20/OBD

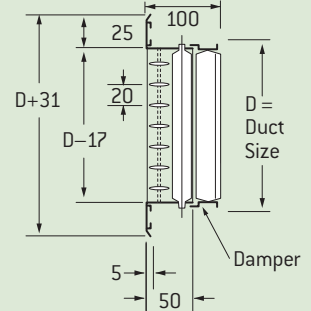

## All Aluminium. 32mm Airfoil Louvers

## Grille - Two Sets of Louver Blades

### Model: DDL-32

Two sets of louver blades. Front set parallel to long dimension. Rear set parallel to short dimension. All louver blades individually adjustable for any degree of deflection.

### Model: DDS-32

Same as DDL-32 except front louver blades parallel to short dimension, rear parallel to long dimension.

Face View, DDL32

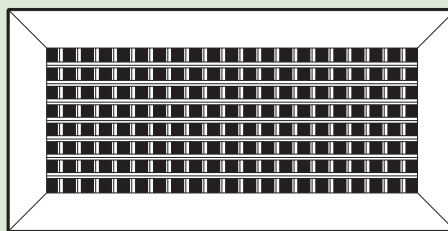

End View, DDL32

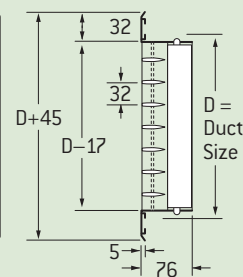

Face View, DDL32/OBD



End View, DDL32/OBD

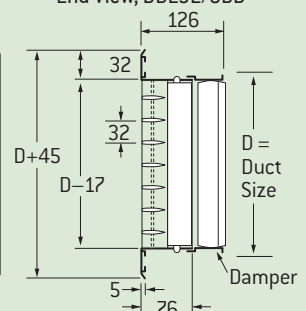

## Register - Two Sets of Louver Blades

### Model: DDL-32/OBD

Two sets of louver blades. Front set parallel to long dimension. Rear set parallel to short dimension. All louver blades individually adjustable for any degree of deflection. Opposed blade damper, screwdriver operated from face.

### Model: DDS-32/OBD

Same as DDL-32/OBD except front louver blades parallel to short dimension, rear parallel to long dimension.

# SUPPLY PERFORMANCE DATA

See Notes and Tables on Page 202E.

Size W X H	Vel. m/s	Vel. Press (Pa)	Tot Press (Pa)	m <sup>3</sup> /s	NC 20			NC 30			NC 40			
					1.52	2.03	2.54	3.05	3.56	4.06	5.08	6.10	7.11	8.13
175 x 100 150 x 125 Ac = 0.014m <sup>2</sup>	2	0°	2	0.020	0.028	0.035	0.042	0.050	0.057	0.071	0.085	0.099	0.113	0.127
	2	0°	4	-	-	-	13	13	17	23	29	34	38	41
	3	22.5°	5	1.2-1.8-3.7	1.5-2.4-4.3	2.1-3.4-4.9	2.4-3.7-5.2	2.7-4.0-5.8	3.4-4.3-6.1	4.0-4.9-6.7	4.3-5.2-7.3	4.6-5.8-7.9	4.9-6.1-8.5	5.2-6.7-9.2
	4	45°	7	0.9-1.5-3.1	1.2-1.8-3.4	1.8-2.4-4.0	1.8-3.1-4.9	2.1-3.1-4.3	2.7-3.4-5.9	2.1-4.0-5.5	3.4-4.3-5.8	3.7-4.6-6.4	4.0-4.9-6.7	4.3-5.5-7.3
200 x 100 175 x 125 150 x 150 Ac = 0.017m <sup>2</sup>	2	0°	3	0.026	0.033	0.042	0.052	0.059	0.068	0.085	0.101	0.118	0.137	0.153
	2	0°	4	-	-	-	10	15	19	25	31	36	40	43
	3	22.5°	5	1.2-1.8-3.7	1.8-2.4-4.3	2.4-3.7-5.8	2.7-4.0-5.8	3.1-4.6-6.1	3.4-4.9-6.7	4.3-5.2-7.3	4.6-5.8-7.9	5.2-6.4-8.8	5.5-6.7-9.5	5.8-7.3-10.2
	4	45°	7	0.9-1.5-3.1	1.2-1.8-3.4	1.8-3.1-4.6	2.1-3.1-4.3	2.4-3.7-4.9	2.7-4.0-5.5	3.4-4.3-5.8	3.7-4.6-6.4	4.3-5.2-7.0	4.3-5.5-7.6	4.6-5.8-7.9
250 x 100 200 x 125 175 x 150 Ac = 0.020m <sup>2</sup>	2	0°	3	0.031	0.042	0.052	0.061	0.073	0.083	0.104	0.125	0.146	0.165	0.186
	2	0°	4	-	-	-	10	15	19	25	31	36	40	43
	3	22.5°	5	1.2-1.8-3.7	1.8-2.4-4.3	2.4-3.7-5.8	2.7-4.0-5.8	3.1-4.6-6.1	3.4-4.9-6.7	4.3-5.2-7.3	4.6-5.8-7.9	5.2-6.4-8.8	5.5-6.7-9.5	5.8-7.3-10.2
	4	45°	7	0.9-1.5-3.1	1.2-1.8-3.4	1.8-3.1-4.6	2.1-3.1-4.3	2.4-3.7-4.9	2.7-4.0-5.5	3.4-4.3-5.8	3.7-4.6-6.4	4.3-5.2-7.0	4.3-5.5-7.6	4.6-5.8-7.9
300 x 100 250 x 125 200 x 150 Ac = 0.024m <sup>2</sup>	2	0°	3	0.038	0.050	0.061	0.073	0.085	0.099	0.123	0.146	0.172	0.196	0.222
	2	0°	4	-	-	-	11	16	20	26	32	37	41	44
	3	22.5°	5	1.2-1.8-3.7	1.8-2.4-4.3	2.4-3.7-5.8	2.7-4.0-5.8	3.1-4.6-6.1	3.4-4.9-6.7	4.3-5.2-7.3	4.6-5.8-7.9	5.2-6.4-8.8	5.5-6.7-9.5	5.8-7.3-10.2
	4	45°	7	0.9-1.5-3.1	1.2-1.8-3.4	1.8-3.1-4.6	2.1-3.1-4.3	2.4-3.7-4.9	2.7-4.0-5.5	3.4-4.3-5.8	3.7-4.6-6.4	4.3-5.2-7.0	4.3-5.5-7.6	4.6-5.8-7.9
350 x 100 Ac = 0.027m <sup>2</sup>	2	0°	3	0.042	0.057	0.071	0.085	0.099	0.113	0.142	0.170	0.188	0.227	0.255
	2	0°	4	-	-	-	11	16	20	26	32	37	41	44
	3	22.5°	5	1.2-1.8-3.7	1.8-2.4-4.3	2.4-3.7-5.8	2.7-4.0-5.8	3.1-4.6-6.1	3.4-4.9-6.7	4.3-5.2-7.3	4.6-5.8-7.9	5.2-6.4-8.8	5.5-6.7-9.5	5.8-7.3-10.2
	4	45°	7	0.9-1.5-3.1	1.2-1.8-3.4	1.8-3.1-4.6	2.1-3.1-4.3	2.4-3.7-4.9	2.7-4.0-5.5	3.4-4.3-5.8	3.7-4.6-6.4	4.3-5.2-7.0	4.3-5.5-7.6	4.6-5.8-7.9
400 x 100 300 x 125 250 x 150 Ac = 0.030m <sup>2</sup>	2	0°	3	0.047	0.064	0.080	0.097	0.113	0.127	0.161	0.194	0.224	0.257	0.288
	2	0°	4	-	-	-	12	17	21	27	33	38	42	45
	3	22.5°	5	1.2-1.8-3.7	1.8-2.4-4.3	2.4-3.7-5.8	2.7-4.0-5.8	3.1-4.6-6.1	3.4-4.9-6.7	4.3-5.2-7.3	4.6-5.8-7.9	5.2-6.4-8.8	5.5-6.7-9.5	5.8-7.3-10.2
	4	45°	7	0.9-1.5-3.1	1.2-1.8-3.4	1.8-3.1-4.6	2.1-3.1-4.3	2.4-3.7-4.9	2.7-4.0-5.5	3.4-4.3-5.8	3.7-4.6-6.4	4.3-5.2-7.0	4.3-5.5-7.6	4.6-5.8-7.9
450 x 100 350 x 125 300 x 150 200 x 200 Ac = 0.036m <sup>2</sup>	2	0°	3	0.054	0.073	0.092	0.111	0.130	0.146	0.184	0.222	0.257	0.295	0.337
	2	0°	4	-	-	-	13	18	22	28	34	39	43	46
	3	22.5°	5	1.2-1.8-3.7	1.8-2.4-4.3	2.4-3.7-5.8	2.7-4.0-5.8	3.1-4.6-6.1	3.4-4.9-6.7	4.3-5.2-7.3	4.6-5.8-7.9	5.2-6.4-8.8	5.5-6.7-9.5	5.8-7.3-10.2
	4	45°	7	0.9-1.5-3.1	1.2-1.8-3.4	1.8-3.1-4.6	2.1-3.1-4.3	2.4-3.7-4.9	2.7-4.0-5.5	3.4-4.3-5.8	3.7-4.6-6.4	4.3-5.2-7.0	4.3-5.5-7.6	4.6-5.8-7.9

# SUPPLY PERFORMANCE DATA

See Notes and Tables on Page 202E.

Size	Vel. Press [Pa]	Vel. m/s	NC 20				NC 30				NC 40			
			1.52	2.03	2.54	3.05	3.56	4.06	5.08	6.10	7.11	8.13	9.14	
WXH	2	3	5	6	8	10	16	23	31	40	51			
	4	7	10	13	17	27	39	53	69	87				
	5	8	11	14	19	30	44	59	77	98				
	7	12	16	22	29	45	66	89	116	147				
500 x 100 400 x 125	0.066	0.087	0.109	0.130	0.151	0.175	0.217	0.260	0.305	0.347	0.392			
	-	-	-	13	18	22	28	34	39	43	46			
	0°	2.7-4.3-7.6	3.7-5.2-8.2	4.3-6.7-9.2	4.9-7.0-9.8	5.8-7.6-10.7	7.0-8.2-11.9	7.6-9.5-13.1	8.2-10.1-14.0	8.8-10.7-14.9	9.5-11.6-15.9			
	22.5°	1.8-2.4-5.5	2.1-3.4-6.1	3.1-4.3-6.7	3.4-5.5-7.3	4.0-5.5-7.9	4.6-6.1-8.5	5.5-6.7-9.5	6.1-7.6-10.4	7.0-8.5-11.9	7.6-9.2-12.8			
250 x 200 Ac = 0.043m²	45°	0.9-1.5-3.4	1.5-2.1-3.7	1.8-2.7-4.3	2.1-3.4-4.6	2.4-3.4-4.9	3.1-4.0-5.2	3.4-4.3-6.1	4.3-5.2-7.0	4.3-5.5-7.3	4.6-5.8-7.9			
	0.073	0.099	0.123	0.146	0.172	0.196	0.246	0.295	0.345	0.382	0.441			
	-	-	-	14	19	23	29	35	40	44	47			
	0°	2.1-3.4-7.0	3.1-4.6-7.9	4.0-5.9-8.8	4.6-6.7-9.8	5.5-7.6-10.7	6.1-7.9-11.3	7.3-9.2-12.5	8.2-10.1-13.7	8.8-10.7-14.9	9.5-11.6-15.9			
300 x 200	22.5°	1.8-2.7-5.5	2.4-3.7-6.4	3.1-4.6-7.0	3.7-5.5-7.9	4.3-6.1-8.5	4.9-6.4-9.2	5.8-7.3-10.1	6.7-7.9-11.0	7.6-9.2-12.8	7.9-9.8-13.4			
	45°	0.9-1.5-3.4	1.5-2.1-4.0	1.8-2.7-4.6	2.4-3.4-4.9	2.7-3.7-5.2	3.1-4.0-5.5	3.7-4.6-6.4	4.0-4.9-7.0	4.6-5.8-7.9	4.9-6.1-8.5			
	0.085	0.113	0.142	0.170	0.198	0.227	0.283	0.340	0.397	0.453	0.510			
	-	-	10	15	20	24	30	36	41	45	48			
500 x 125 450 x 150	2.1-3.7-7.3	3.4-4.9-8.5	4.3-6.1-9.5	4.9-7.3-10.4	5.8-8.2-11.3	6.7-8.8-12.2	7.9-9.8-13.7	8.8-10.7-14.6	9.5-11.6-15.9	10.7-12.2-17.1	10.7-13.1-18.0			
	22.5°	1.8-3.1-5.8	2.7-4.0-6.7	3.4-4.9-7.6	4.0-5.8-8.2	4.6-6.7-9.2	5.5-7.0-9.8	6.4-7.9-11.0	7.0-8.5-11.6	7.9-9.8-13.7	8.5-10.4-14.3			
	45°	1.2-1.8-3.7	1.5-2.4-4.3	2.1-3.1-4.9	2.4-3.7-5.2	3.1-4.0-5.8	3.4-4.3-6.1	4.0-4.9-6.7	4.3-5.2-7.3	4.6-5.8-7.9	5.2-6.4-8.8			
	0.097	0.130	0.163	0.196	0.229	0.260	0.326	0.392	0.456	0.519	0.585			
350 x 200 300 x 250	2.4-4.0-7.9	3.7-5.2-9.2	4.6-6.7-10.4	5.5-7.9-11.3	6.4-8.8-12.2	7.3-9.5-13.1	8.5-10.4-14.3	9.2-11.6-15.9	10.1-12.2-17.1	10.7-13.1-18.3	11.3-13.7-19.2			
	22.5°	1.8-3.1-6.4	3.1-4.3-7.3	3.7-5.5-8.2	4.3-6.4-9.2	5.2-7.0-9.8	5.8-7.6-10.4	6.7-8.2-11.6	7.3-9.2-12.8	8.5-10.4-14.6	9.2-11.0-15.3			
	45°	1.2-1.8-4.0	1.8-2.7-4.6	2.1-3.4-5.2	2.7-4.0-5.5	3.1-4.3-6.1	3.7-4.6-6.4	4.3-5.2-7.3	4.6-5.8-7.9	5.5-6.7-9.2	5.8-7.0-9.5			
	0.113	0.153	0.191	0.229	0.267	0.307	0.382	0.458	0.534	0.614	0.689			
550 x 150 400 x 200	-	-	11	16	21	25	31	37	42	46	49			
	0°	2.4-4.3-8.5	4.0-5.8-10.1	4.9-7.0-11.3	5.8-8.5-12.2	7.0-9.5-13.1	7.9-10.1-14.0	9.2-11.3-15.6	10.1-12.5-17.1	11.0-13.4-18.3	11.6-14.0-19.5			
	22.5°	1.8-3.4-6.7	3.1-4.6-7.9	4.0-5.5-9.2	4.6-6.7-9.8	5.5-7.6-10.4	6.4-7.9-11.3	7.3-9.2-12.5	7.9-10.1-13.7	8.8-10.7-14.6	9.2-11.3-15.6			
	45°	1.2-2.1-4.3	1.8-2.7-4.9	2.4-3.7-5.5	3.1-4.3-6.1	3.4-4.6-6.7	4.0-5.2-7.0	4.6-5.8-7.9	5.2-6.1-8.5	5.5-6.7-9.2	5.8-7.0-9.8			
650 x 150 450 x 200	0.127	0.170	0.212	0.225	0.297	0.340	0.425	0.510	0.595	0.680	0.765			
	-	-	11	16	21	25	31	37	42	46	49			
	0°	2.7-4.6-9.2	4.3-6.1-10.4	5.2-7.6-11.9	6.4-9.2-12.8	7.3-10.1-13.7	8.2-10.7-14.6	9.2-11.9-16.8	10.7-13.1-18.0	11.3-14.0-19.2	12.2-14.9-20.7			
	22.5°	2.1-3.7-7.3	3.4-4.9-8.2	4.3-6.1-9.5	5.2-7.3-10.4	5.8-7.9-11.0	6.7-8.5-11.6	7.9-9.5-13.4	8.5-10.4-14.3	9.2-11.3-15.3	9.8-11.9-16.5			
300 x 300 Ac = 0.084m²	45°	1.5-2.4-4.6	2.1-3.1-5.2	2.7-4.0-5.8	3.1-4.6-6.4	3.7-4.9-7.0	4.3-5.2-7.3	4.9-6.1-8.2	5.8-7.0-9.8	6.1-7.3-10.4	6.4-7.9-11.0			
	0.151	0.203	0.253	0.302	0.354	0.404	0.505	0.604	0.708	0.807	0.911			
	-	-	11	16	21	25	31	37	42	46	49			
	0°	3.1-4.9-9.8	4.6-6.7-11.6	5.5-8.5-12.8	6.7-10.1-14.0	7.6-11.0-14.9	8.8-11.6-16.2	10.7-13.1-18.0	11.6-14.0-19.1	12.5-15.3-21.0	13.1-16.2-22.6			
450 x 250 350 x 300	22.5°	2.4-4.0-7.9	3.7-5.5-9.2	4.3-6.7-10.4	5.5-7.9-11.3	6.4-8.8-11.9	7.0-9.2-12.8	8.5-10.4-14.3	9.2-11.3-15.6	10.4-12.8-18.0	11.3-14.0-19.2			
	45°	1.5-2.4-4.9	2.1-3.4-5.8	2.7-4.3-6.4	3.4-5.2-7.0	4.0-5.5-7.6	4.3-5.8-7.9	5.2-6.4-8.8	6.1-7.6-10.7	6.7-8.2-11.3	7.0-8.5-12.2			
	0.151	0.203	0.253	0.302	0.354	0.404	0.505	0.604	0.708	0.807	0.911			
	-	-	11	16	21	25	31	37	42	46	49			

# SUPPLY PERFORMANCE DATA

See Notes and Tables on Page 202E.

Size	Vel. m/s	Vel. Press (Pa)	Tot Press (Pa)	m <sup>3</sup> /s	NC 20				NC 30				NC 40				NC 50
					1.52	2.04	2.54	3.05	3.56	4.06	5.08	6.10	7.11	8.13	9.14		
600 x 200	2	0.168	0.222	0.279	0.335	0.390	0.446	0.557	0.670	0.779	0.892	1.000					
500 x 250	-	-	-	12	17	22	26	32	38	43	47	50					
350 x 350	3	3.1-5.2-10.4	4.6-7.0-12.2	5.8-8.5-13.4	7.0-10.7-14.6	8.2-11.6-15.9	9.5-12.2-17.1	11.0-13.7-18.9	12.2-14.6-20.4	13.1-15.9-22.3	13.7-17.1-23.8	14.6-18.0-25.3					
Ac = 0.11 m <sup>2</sup>	0°	2.4-4.3-8.2	3.7-5.5-9.8	4.6-6.7-10.7	5.5-8.5-11.6	6.7-9.2-12.8	7.6-9.8-13.7	8.8-11.0-15.3	9.8-11.6-16.5	10.4-12.8-17.7	11.0-13.7-18.9	11.6-14.3-20.1					
	22.5°	1.5-2.4-5.2	2.4-3.4-6.1	3.1-4.3-6.7	3.7-5.2-7.3	4.0-5.8-7.9	4.6-6.1-8.5	5.5-6.7-9.5	6.1-7.3-10.4	6.4-7.9-11.0	7.0-8.5-11.9	7.3-9.2-12.5					
900 x 150	2	0.189	0.253	0.316	0.380	0.444	0.505	0.633	0.760	0.888	1.010	1.140					
700 x 200	-	-	-	13	18	23	27	33	39	44	48	51					
500 x 300	3	3.4-5.5-11.0	4.9-7.3-12.8	6.1-9.2-14.3	7.3-11.3-15.6	8.5-12.2-17.1	9.8-13.1-18.0	11.9-14.3-19.8	12.8-15.9-22.0	13.7-17.1-23.8	14.6-18.3-25.3	15.6-19.2-27.2					
450 x 300	0°	2.7-4.3-8.8	4.0-5.8-10.4	4.9-7.3-11.6	5.8-9.2-12.5	6.7-9.8-13.7	7.9-10.4-14.3	9.5-11.6-15.9	10.4-12.8-17.7	11.0-13.7-18.9	11.6-14.6-20.1	12.5-15.3-21.7					
400 x 350	22.5°	1.8-2.7-5.5	2.4-3.7-6.4	3.1-4.6-7.0	3.7-5.5-7.6	4.3-6.1-8.5	4.9-6.4-8.8	5.8-7.0-10.1	6.4-7.9-11.0	7.0-8.5-11.9	7.3-9.2-12.9	7.9-9.8-13.4					
Ac = 0.12 m <sup>2</sup>	45°	0.227	0.302	0.378	0.453	0.529	0.604	0.756	0.907	1.060	1.210	1.360					
	0°	-	-	13	18	23	27	33	39	44	48	51					
600 x 250	4	4.0-6.1-12.2	5.5-7.9-14.0	6.7-9.8-15.6	8.2-11.9-17.1	9.5-13.1-18.3	10.7-14.0-19.5	12.8-15.6-22.0	14.0-17.1-24.1	14.9-18.6-25.9	16.2-19.8-27.8	17.1-21.0-29.6					
550 x 300	0°	3.1-4.9-9.8	4.3-6.4-11.3	5.5-7.9-12.5	6.7-9.5-13.7	7.6-10.4-14.6	8.5-11.3-15.6	10.4-12.5-17.7	11.3-13.7-19.2	11.9-14.9-20.7	12.8-15.9-22.3	13.7-16.8-23.8					
450 x 350	22.5°	1.8-3.1-6.1	2.7-4.0-7.0	3.4-4.9-7.6	4.0-6.1-8.5	4.6-6.7-9.2	5.2-7.0-9.8	6.4-7.9-11.0	7.0-8.5-11.9	7.6-9.2-13.1	7.9-9.8-14.0	8.5-10.7-14.6					
Ac = 0.14 m <sup>2</sup>	45°	0.255	0.340	0.425	0.510	0.595	0.680	0.850	1.020	1.190	1.360	1.530					
	0°	-	-	14	19	24	28	34	40	45	49	52					
600 x 300	4	4.0-6.4-12.8	5.8-8.5-14.6	7.3-10.7-16.8	8.8-13.1-18.0	9.8-14.0-19.2	11.3-14.9-20.7	13.7-16.8-23.2	14.6-18.3-25.6	15.9-19.8-27.5	17.1-21.0-29.6	18.3-22.3-31.4					
500 x 350	0°	3.1-5.2-10.4	4.6-6.7-11.6	5.8-8.5-13.4	7.0-10.4-14.3	7.9-11.3-15.3	9.2-11.9-16.5	11.0-13.4-18.6	11.6-14.6-20.4	12.8-15.9-22.0	13.7-16.8-23.8	14.6-17.7-25.0					
450 x 400	22.5°	2.1-3.4-6.4	2.7-4.3-7.3	3.7-5.2-8.2	4.3-6.4-8.8	4.9-7.0-9.8	5.8-7.3-10.4	6.7-8.2-11.6	7.3-9.2-11.8	7.9-9.8-13.7	8.5-10.7-14.6	9.2-11.3-15.6					
Ac = 0.16 m <sup>2</sup>	45°	0.295	0.392	0.491	0.590	0.689	0.784	0.982	1.180	1.370	1.570	1.770					
	0°	-	-	14	19	24	28	34	40	45	49	52					
750 x 300	4	4.3-7.0-13.7	6.1-9.2-15.9	7.9-11.6-17.7	9.2-13.4-19.2	10.7-14.9-20.7	12.2-16.2-22.3	14.6-18.0-25.0	15.9-19.5-27.5	17.1-21.0-29.6	18.3-22.9-31.7	19.5-24.1-33.6					
900 x 250	0°	3.4-5.5-11.0	4.9-7.3-12.8	6.4-9.2-14.0	7.3-10.7-15.3	8.5-11.9-16.5	9.8-12.8-17.7	11.6-14.3-20.1	12.8-15.6-21.7	14.0-17.1-23.8	14.9-18.6-25.9	15.9-19.8-27.5					
500 x 400	22.5°	2.1-3.4-7.0	3.1-4.6-7.9	4.0-5.8-8.8	4.6-6.7-9.8	5.2-7.6-10.4	6.1-11.0-11.3	7.3-8.8-12.5	7.9-9.8-13.7	8.5-10.7-14.9	9.8-11.6-16.7	10.1-12.8-17.1					
450 x 450	45°	0.347	0.463	0.576	0.694	0.812	0.925	1.160	1.390	1.620	1.850	2.080					
Ac = 0.20 m <sup>2</sup>	45°	-	-	15	20	25	29	35	41	46	50	53					
	0°	4.6-7.6-14.9	6.7-10.1-17.4	8.2-12.2-18.9	9.8-14.6-20.7	11.6-16.5-22.6	13.1-17.4-24.4	15.9-19.5-27.2	17.4-21.4-29.6	18.6-23.2-32.3	19.8-24.7-34.5	21.4-26.5-36.6					
650 x 350	0°	3.7-6.1-11.9	5.5-7.9-14.0	6.7-9.8-15.3	7.9-11.6-16.5	9.2-13.1-18.0	10.4-14.0-19.5	12.8-15.6-21.7	14.0-17.1-23.8	14.9-18.6-25.9	15.9-19.8-27.5	17.1-21.4-29.3					
600 x 400	22.5°	2.1-3.7-7.3	3.4-4.9-8.5	4.3-6.1-9.5	4.9-7.3-10.4	5.8-8.2-11.3	6.7-8.5-12.2	7.9-9.8-13.7	8.5-10.7-14.9	9.8-11.6-16.7	10.1-12.8-17.1	10.7-13.1-18.3					
450 x 450	45°	0.390	0.524	0.656	0.788	0.921	1.050	1.310	1.580	1.840	2.100	2.360					
Ac = 0.22 m <sup>2</sup>	45°	-	-	16	21	26	30	36	42	47	51	54					
	0°	4.9-7.9-15.9	7.0-10.4-18.3	8.8-12.8-20.4	10.7-15.3-22.2	12.2-17.4-24.1	13.7-18.6-25.9	16.8-20.7-29.0	20.1-22.9-31.7	21.4-26.5-37.2	22.6-28.4-39.0	24.1-30.0-41.9	25.6-32.5-45.4				
900 x 300	0°	4.0-6.4-12.8	5.5-8.2-14.6	7.0-10.4-16.5	8.5-12.2-17.7	9.8-14.0-19.2	11.0-14.9-20.7	13.4-16.5-23.2	14.6-18.3-25.3	15.9-19.8-27.5	17.1-21.4-29.9	18.0-22.6-31.1					
650 x 400	22.5°	2.4-4.0-7.9	3.7-5.2-9.2	4.3-6.4-10.1	5.2-7.6-11.3	6.1-8.5-12.2	7.0-9.2-12.8	8.5-10.4-14.3	9.2-11.3-15.9	10.1-12.2-17.1	10.7-13.1-18.6	11.3-14.0-19.5					
550 x 500	45°	0.255	0.340	0.425	0.510	0.595	0.680	0.850	1.020	1.190	1.360	1.530					
Ac = 0.25 m <sup>2</sup>	45°	-	-	16	21	26	30	36	42	47	51	54					
	0°	4.9-7.9-15.9	7.0-10.4-18.3	8.8-12.8-20.4	10.7-15.3-22.2	12.2-17.4-24.1	13.7-18.6-25.9	16.8-20.7-29.0	20.1-22.9-31.7	21.4-26.5-37.2	22.6-28.4-39.0	24.1-30.0-41.9	25.6-32.5-45.4				

Sidewall Supply Grilles



# SUPPLY PERFORMANCE DATA

See Notes and Tables on Page 202E.

Size W X H	Vel. m/s	Vel. Press (Pa)	Tot Press (Pa)	m³/s	NC 20					NC 30					NC 40					NC 50						
					1.52	2.03	2.54	3.05	3.56	4.06	5.08	6.10	7.11	8.13	9.14	1.52	2.03	2.54	3.05	3.56	4.06	5.08	6.10	7.11	8.13	9.14
750 x 400	0.441	0.585	0.747	0.883	1.030	1.180	1.470	1.760	2.050	2.350	2.640															
650 x 450	-	-	16	21	26	30	36	42	47	51	54															
600 x 500	0°	73.11.0-19.2	10.4-13.7-21.7	12.5-16.2-23.8	14.3-18.3-25.6	14.6-19.5-27.5	17.7-22.0-30.5	19.5-24.1-33.6	21.0-26.2-36.0	22.6-28.1-39.0	24.1-29.6-41.2															
550 x 550	22.5°	3.1-8.8-15.3	8.2-11.0-17.4	10.1-12.8-18.9	11.6-14.6-20.4	11.6-15.6-22.0	14.0-17.7-24.4	15.6-19.2-26.8	16.8-21.0-28.7	18.0-22.6-31.1	19.2-23.8-32.9															
Ac = 0.28m²	45°	2.4-4.3-8.5	3.7-5.5-9.5	5.2-6.7-10.7	6.1-7.9-11.9	7.3-9.8-12.7	8.8-11.0-15.3	9.8-12.2-16.8	10.7-13.1-18.0	11.3-14.0-19.5	12.2-14.9-20.4															
900 x 400	0.510	0.680	0.850	1.020	1.190	1.360	1.700	2.040	2.380	2.730	3.070															
750 x 450	-	10	17	22	27	31	37	43	48	52	55															
700 x 500	0°	7.9-11.6-20.7	9.8-14.3-23.2	11.6-17.1-25.6	13.4-19.8-27.5	15.6-21.0-29.6	19.2-23.8-32.9	21.0-26.2-36.0	22.9-28.4-39.0	24.4-30.2-41.8	26.2-32.0-44.5															
600 x 600	22.5°	4.3-7.0-14.3	6.4-9.2-16.5	7.9-11.6-18.6	9.2-13.7-20.4	10.7-15.9-22.0	12.5-16.8-23.8	15.3-18.9-26.2	16.8-21.0-28.7	18.3-22.6-31.1	19.2-23.8-32.9															
Ac = 0.33m²	45°	2.7-4.3-8.8	4.0-5.8-10.4	4.9-7.0-11.6	5.8-8.5-12.8	6.7-9.8-13.7	7.6-10.7-14.6	9.5-11.9-16.5	10.7-13.1-18.0	11.6-14.3-19.8	12.2-15.3-21.0															
900 x 450	0.610	0.812	1.010	1.210	1.420	1.620	2.030	2.430	2.890	3.240	3.640															
800 x 500	-	11	18	23	28	32	38	44	49	53	56															
700 x 550	0°	8.5-12.5-22.6	10.7-15.3-25.3	12.8-18.3-27.8	14.9-21.7-29.9	17.1-23.2-32.3	21.0-25.9-36.0	23.2-28.4-39.0	25.0-31.1-42.7	26.8-32.9-45.4	28.1-35.1-48.2															
600 x 650	22.5°	4.6-7.6-15.6	6.7-10.1-18.0	8.5-12.2-20.1	10.4-14.6-22.3	11.9-17.4-23.8	13.7-18.6-25.9	16.8-20.7-28.7	18.6-22.6-31.7	20.1-25.0-34.2	21.4-26.2-36.3															
Ac = 0.39m²	45°	3.1-4.6-9.8	4.3-6.1-11.3	5.2-7.6-12.8	6.4-9.2-14.0	7.3-10.7-14.9	8.5-11.6-16.2	10.4-13.1-18.0	11.6-14.3-19.8	12.5-15.6-21.4	13.4-16.5-22.9															
900 x 500	0.660	0.878	1.100	1.320	1.540	1.760	2.200	2.630	3.070	3.510	3.950															
750 x 600	-	11	18	23	28	32	38	44	49	53	56															
700 x 650	0°	6.1-10.1-20.4	8.8-13.1-23.8	11.0-16.5-26.5	13.4-19.8-29.0	15.6-22.6-31.4	17.7-24.1-33.6	22.0-27.2-37.5	24.1-29.6-41.2	26.2-32.0-44.5	27.8-34.5-47.6															
600 x 750	22.5°	4.9-7.9-16.5	7.0-10.4-18.9	8.8-13.1-21.4	10.7-15.9-23.2	12.5-18.0-25.0	14.0-19.2-26.8	17.7-21.7-29.9	19.2-23.8-32.9	21.0-25.9-35.7	22.3-27.5-38.1															
Ac = 0.42 m²	45°	3.1-4.9-10.1	4.6-6.7-11.9	5.5-8.2-13.1	6.7-9.8-14.6	7.6-11.3-15.9	8.8-12.2-16.8	11.0-13.4-18.6	11.9-14.9-20.4	13.1-15.9-22.3	14.0-17.1-23.8															
1200 x 450	0.788	1.050	1.320	1.580	1.850	2.110	2.630	3.160	3.690	4.220	4.720															
900 x 600	-	12	19	24	29	33	39	45	50	54	57															
700 x 750	0°	6.7-11.0-22.3	9.5-14.3-25.9	12.2-18.0-29.0	14.3-22.0-31.7	16.8-24.7-34.5	19.2-26.5-37.2	24.1-29.6-39.6	26.5-32.6-45.1	28.4-35.4-48.8	30.5-38.1-52.2															
600 x 850	22.5°	5.5-8.8-17.7	7.6-11.6-20.7	9.8-14.4-23.3	11.6-17.7-25.3	13.4-19.8-27.5	15.3-21.4-29.9	19.2-23.8-32.9	21.4-26.2-36.0	22.6-28.4-39.7	24.4-30.5-41.8															
Ac = 0.51m²	45°	3.4-5.5-11.3	4.9-7.0-13.1	6.1-9.2-14.6	7.0-11.0-15.9	8.5-12.5-17.4	9.5-13.4-18.6	11.9-14.9-20.4	13.1-16.2-22.6	14.3-17.7-24.4	15.3-18.9-26.2															
1200 x 500	0.888	1.180	1.470	1.770	2.070	2.360	2.950	3.540	4.130	4.720	5.290															
750 x 750	-	13	20	25	30	34	40	46	51	55	58															
600 x 850	0°	7.0-11.3-23.8	10.1-14.9-27.5	12.8-18.9-30.5	15.3-22.9-31.4	17.7-26.2-36.3	20.4-28.4-39.0	25.6-31.7-43.6	28.1-34.5-47.6	29.9-37.5-51.5	32.3-40.3-54.9															
500 x 950	22.5°	5.5-9.2-18.9	7.9-11.9-22.0	10.4-15.3-24.4	12.2-18.3-25.0	14.0-21.0-29.0	16.5-22.6-31.1	20.4-25.3-34.8	22.6-27.5-38.1	23.8-29.9-41.2	25.9-32.0-42.7															
Ac = 0.56m²	45°	3.7-5.8-11.9	5.2-7.6-13.7	6.4-9.5-15.3	7.6-11.3-15.6	8.8-13.1-18.3	10.4-14.0-19.5	12.8-15.9-22.0	14.0-17.4-23.8	14.9-18.6-25.9	16.2-20.1-29.3															

# MDD – Long Throw Modular Grille

**High Capacity.**

**Long, or Short Throw.**

**Directional Control.**

Heavy duty supply grille with extended pattern adjustment. Delivers long and narrow, or short and wide jets, depending on louver setting. Modules can direct different shapes of jets to different parts of a room simultaneously.

Especially well-suited to such spaces as factories, warehouses, airports, coliseums and shopping malls. Excellent for spot cooling, or spot heating.

## Features

- Louver depth-to-spacing ratio of 1.0 for directional control that equals, or surpasses that of any other air directing outlet.
- Airfoil louvers for minimum turbulence.
- Two sets of individually adjustable louvers in each module. One vertical, one horizontal.
- Modules removable and rotatable for changing jet direction, without disturbing louver setting.

## Material

Louvers and frames extruded aluminium. Volume control optional. Specify OBD if required.

W = Nominal Duct Width				H = Nominal Duct Height
MDD 1	MDD 2	MDD 3	MDD 4	
200	450	700	950	200
250	550	850	1150	250
300	650	1000	1350	300
375	800	1225	1650	375

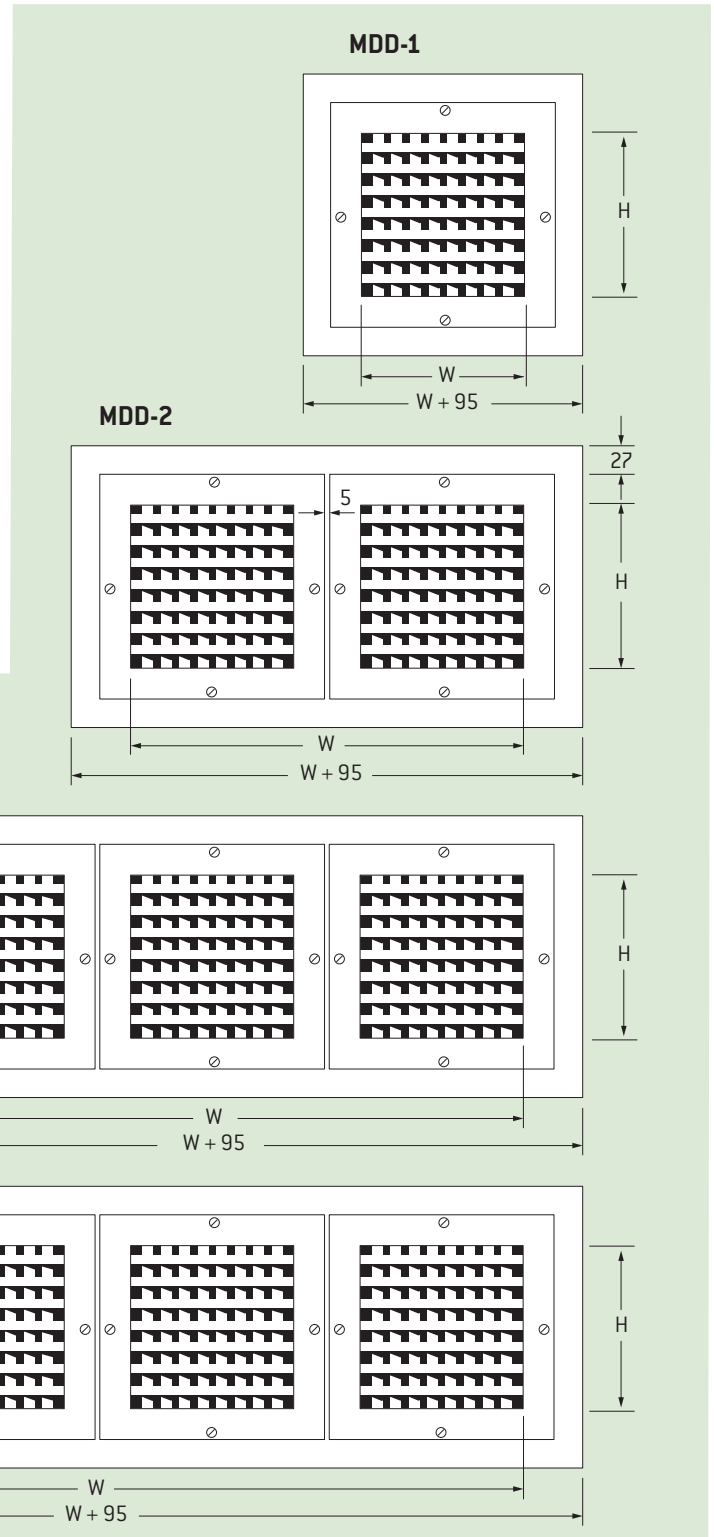
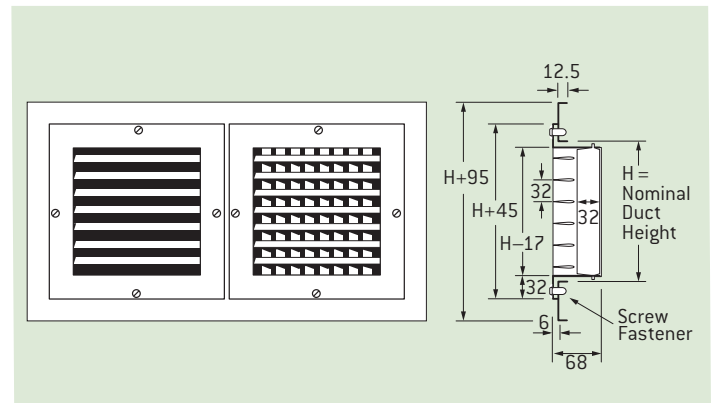

- Pressure: All pressures are in pascals.
- Throw: All throws are to a terminal velocity of 0.25 m/s. The longer throw is for a 0 degree deflection, while the shorter throw is for a 45 degree deflection.
- Sound: The NC values are based on a room absorption of 10 dB, re 10<sup>-12</sup> watts, with a single register operating at a 0 degree deflection setting. The 45 degree setting increases the stated sound level by 7 NC.

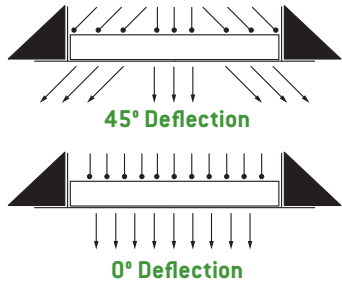

MODEL	SIZE	Vel. m/s		3.06	3.57	4.08	5.10	6.12	7.14	8.16	9.18
		Total Press (Pa)	0°	7	10	13	20	28	38	50	63
			45°	11	16	21	32	47	64	83	106
MDD-1	200	m <sup>3</sup> /s		0.104	0.120	0.137	0.172	0.208	0.241	0.274	0.311
		THROW (m)		4.3-8.2	4.6-8.8	4.9-9.4	5.5-10.7	5.8-11.9	6.4-12.5	6.7-13.4	7-14.3
		NC		13	18	17	23	29	34	38	41
	250	m <sup>3</sup> /s		0.170	0.198	0.227	0.283	0.340	0.396	0.453	0.510
		THROW (m)		5.2-10.4	5.8-11.3	6.1-12.2	6.7-13.7	7.3-14.6	7.9-15.8	8.5-17.1	8.8-18
		NC		11	16	20	26	32	37	41	44
	300	m <sup>3</sup> /s		0.250	0.293	0.330	0.415	0.500	0.580	0.665	0.746
		THROW (m)		6.4-12.8	7-13.7	7.3-14.6	8.2-16.8	8.8-18	9.8-19.2	10.4-20.7	11-21.9
		NC		11	16	20	26	32	37	41	44
	375	m <sup>3</sup> /s		0.396	0.462	0.529	0.661	0.793	0.925	1.060	1.190
		THROW (m)		7.6-15.5	8.5-17.1	8.8-18	10.1-19.8	11-21.9	11.9-23.8	12.8-25.3	13.4-27.1
		NC		13	18	22	28	34	39	43	46
MDD-2	200	m <sup>3</sup> /s		0.208	0.241	0.274	0.344	0.415	0.481	0.552	0.618
		THROW (m)		5.5-11.3	6.4-12.5	6.7-13.4	7.6-15.2	8.2-16.5	8.8-17.7	9.4-18.9	9.8-19.5
		NC		15	15	19	25	31	36	40	43
	250	m <sup>3</sup> /s		0.340	0.396	0.453	0.566	0.680	0.793	0.906	1.02
		THROW (m)		7.3-14.6	7.9-15.8	8.5-17.1	9.4-18.9	10.4-20.4	11-22.3	11.9-23.8	12.5-25.3
		NC		12	17	21	27	33	38	42	45
	300	m <sup>3</sup> /s		0.495	0.580	0.665	0.831	0.996	1.160	1.330	1.500
		THROW (m)		8.8-18	9.8-19.2	10.4-20.7	11.6-23.2	12.8-25.6	13.7-27.4	14.6-29.6	15.5-31.4
		NC		14	19	23	29	35	40	44	47
	375	m <sup>3</sup> /s		0.793	0.925	1.060	1.320	1.590	1.850	2.110	2.380
		THROW (m)		11.3-22.3	12.2-24.1	12.8-25.9	14.3-29	15.9-31.7	17.1-34.1	18.6-37.2	19.5-39
		NC		16	21	25	31	37	42	46	49
MDD-3	200	m <sup>3</sup> /s		0.311	0.363	0.415	0.519	0.623	0.727	0.831	0.934
		THROW (m)		7.0-14.0	7.6-14.9	7.9-16.2	8.8-18	9.8-19.5	10.7-21	11.3-22.6	12.2-24.1
		NC		11	16	20	26	32	37	41	44
	250	m <sup>3</sup> /s		0.510	0.595	0.680	0.849	1.020	1.190	1.360	1.530
		THROW (m)		8.8-18	9.8-19.2	10.4-20.7	11.6-23.2	12.8-25.6	13.7-27.4	14.6-29.6	15.5-31.4
		NC		14	19	23	29	35	40	44	47
	300	m <sup>3</sup> /s		0.746	0.873	0.996	1.250	1.500	1.770	1.990	2.240
		THROW (m)		10.7-21.3	11.6-23.5	12.5-25	14-28.1	15.2-30.8	16.5-33.2	18-36	18.9-37.8
		NC		16	21	25	31	37	42	46	49
	375	m <sup>3</sup> /s		1.190	1.390	1.590	1.980	2.380	2.770	3.170	3.570
		THROW (m)		14-27.7	14.9-29.9	16.2-32.3	18-36	19.8-39.6	21.3-42.7	22.9-45.4	24.1-48.2
		NC		18	23	27	33	39	44	48	51
MDD-4	200	m <sup>3</sup> /s		0.415	0.481	0.552	0.689	0.826	0.963	1.100	1.240
		THROW (m)		8.2-16.5	8.8-17.7	9.1-18.6	10.4-20.7	11.6-22.9	12.5-25	13.4-26.5	14-28.3
		NC		13	18	22	28	34	39	43	46
	250	m <sup>3</sup> /s		0.680	0.793	0.906	1.130	1.360	1.590	1.810	2.040
		THROW (m)		10.4-20.7	11.3-22.6	12.2-24.4	13.7-27.1	14.9-29.6	16.2-32.3	17.1-34.4	18.3-36.6
		NC		15	20	24	30	36	41	45	48
	300	m <sup>3</sup> /s		0.991	1.160	1.320	1.650	1.980	2.310	2.640	2.970
		THROW (m)		12.5-25	13.4-26.8	14.3-29	16.2-32.3	17.7-35.4	19.2-38.7	20.7-41.1	21.9-43.9
		NC		17	22	26	32	38	43	47	50
	375	m <sup>3</sup> /s		1.590	1.850	2.110	2.640	3.170	3.700	4.230	4.720
		THROW (m)		15.8-31.7	17.4-34.4	18.6-37.2	20.4-41.1	22.6-45.1	24.4-48.8	26.2-52.1	27.4-54.9
		NC		19	24	28	34	40	45	49	52

Sidewall Supply Grilles



# SD, DD, TLC & MDD

## Grille Description Code Examples and Suggested Specifications

SD	L or S	20 or 32	RC	25	OBD-1	– W x H (DUCT)	FINISH
DD	L or S	20 or 32	RC	50			
TLC-SD	L	20	–	CMF			
TLC-DD	L	20	–				
MDD	–	20 or 32	RC (Screw)				

  

Single Deflection. Double Deflection. Curved Frame, Single Deflection. Curved Frame, Double Deflection. Modular Double Deflection.	Direction of Front Blades, (L - Parallel to long dimension, S - Parallel to short dimension).	Blade Spacing (mm).	Removable Core Frame*.	Optional Frame Styles.	Opposed Blade Damper.	Width x Height Dimensions.	Holyoake White. Mill Aluminium. Powder Coat.
---	---	---------------------------	---------------------------	------------------------------	-----------------------------	-------------------------------	--

All Holyoake sidewall supply registers shall be of extruded aluminium construction, with true airfoil shaped single, or double deflection blades. Optional opposed blade volume control damper, which can be screw driver operated through the face of the grille. All shall be as manufactured by Holyoake.

\* = See page 228E (For MDD, see page 210E).

Guide Product Weights	
Description	Approximate Weight in Kg.
MDD	SUBJECT TO CORE ELEMENTS
Contact your local Holyoake Branch	

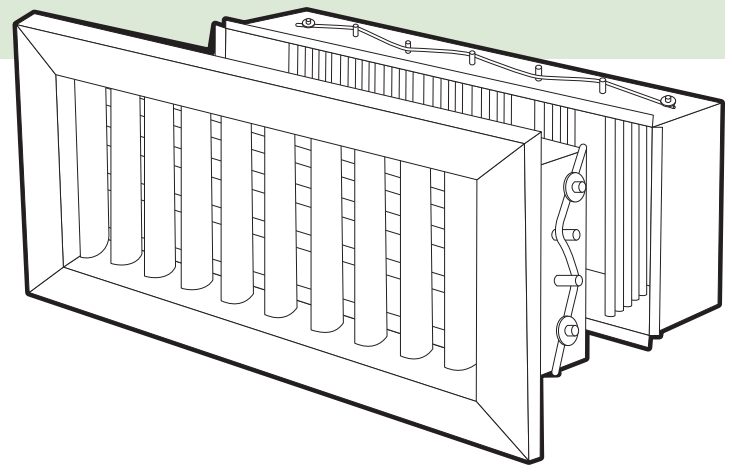

**Note**  
Where appropriate, seismic restraints may be required, but are not supplied.